

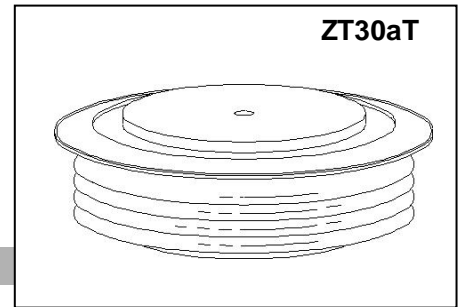

GENERAL PURPOSE HIGH POWER STANDARD RECTIFIER

Features:

- . All diffused structure
- . High surge rating
- . Blocking capability up to 3500 volts
- . Ceramic housing hermetic package
- . Pressure assembled device



ELECTRICAL CHARACTERISTICS AND RATINGS

Reverse Blocking

Device Type	V _{RRM} (1)	V _{RSM} (1)
ZP700-25	2500	2700
ZP700-26	2600	2800
ZP700-28	2800	3000
ZP700-30	3000	3200
ZP700-32	3200	3400
ZP700-35	3500	3700

V_{RRM} = Repetitive peak reverse voltage

V_{RSM} = Non repetitive peak reverse voltage (2)

Repetitive peak reverse leakage current	I _{RRM}	2 mA 30 mA (3)
---	------------------	-------------------

Notes:

All ratings are specified for T_j=25 °C, unless otherwise stated

(1) All voltage ratings are specified for an applied 50Hz/60Hz sinusoidal waveform over the temperature range 0 to +175 °C.

(2) 10 msec. max. pulse width

(3) Maximum value for T_j = 175 °C.

(4) See parameter definition below :

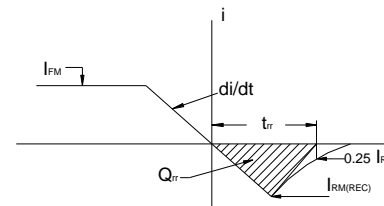

REVERSE RECOVERY CHARACTERIST

Conducting - on state

Parameter	Symbol	Min.	Max.	Typ.	Units	Conditions
Average forward current	I _{F(AV)}		700		A	Sinewave 180°, T _c =100°C
RMS forward current	I _{FRMS}		1099		A	Nominal value
Peak one cycle surge (non repetitive) current	I _{FSM}		9800		A	10 msec (50Hz), sinusoidal wave-shape, 180° conduction, T _j = 175 °C
I square t	I ² t		48 × 10 ⁴		A ² s	10 msec
Peak forward voltage	V _{FM}		1.95		V	I _{FM} = 1500A; T _j =25°C
Threshold voltage	V _{FO}		0.88		V	T _j =175°C, I = 0.5 π I _{F(AV)} to 1.5 π I _{F(AV)}
Slope resistance	r _F		0.50		mΩ	T _j =175°C, I = 0.5 π I _{F(AV)} to 1.5 π I _{F(AV)}
Reverse Recovery Current (4)	I _{RM(REC)}				A	I _{FM} = 500 A; di/dt = -10 A/s; T _{jmax}
Reverse Recovery Charge (4)	Q _{rr}			2000	μC	I _{FM} = 500 A; di/dt = -10 A/s; T _{jmax}
Reverse Recovery Time (4)	t _{rr}				μs	I _{FM} = 500 A; di/dt = -10 A/s; T _{jmax}

Parameter	Symbol	Min.	Max.	Typ.	Units	Conditions
Operating temperature	T_j	-40	+175		°C	
Storage temperature	T_{stg}	-40	+175		°C	
Thermal resistance - junction to case	$R_{\Theta(j-c)}$		0.054		°C/W	Double sided cooled
Thermal resistance - case to heatsink	$R_{\Theta(c-s)}$		0.01		°C/W	Double sided cooled
Mounting force	P	9	11	10	kN	
Weight	W			0.08	kg.	

* Mounting surfaces smooth, flat and greaseless

CASE OUTLINE AND DIMENSIONS

